

Description

The SMA6L series is designed specifically to protect sensitive electronic equipment from voltage transients induced by lightning and other transient voltage events. The SMA6L low profile package has the same power performance as the SMB package but with lowest height profiles (1.1 mm) in the industry.

Applications

- Communication Equipment
- Security & Protection
- Industrial Control Equipment
- Power Supply
- Automotive Electronics
- New Energy
- Lightning Protection

Functional Diagram

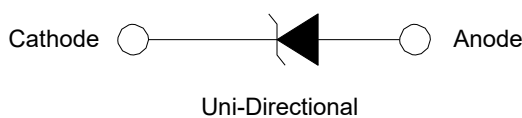

Features

- Same power as standard SMB devices (600 W)
- SMA low profile package: less than 1.1 mm
- Footprint compatibility with standard SMA and SMB products (easy to layout)
- Typical failure mode is a short circuit condition for current events exceeding component rating
- Whisker test is conducted based on JEDEC JESD201A per its table 4a and 4c
- IEC 61000-4-2 ESD 30 kV (Air), 30 kV (Contact)
- EFT protection of data lines in accordance with IEC 61000-4-4
- Low inductance, excellent clamping capability
- Fast response time: typically less than 1.0 ns from 0 Volts to V_{BR} min
- Built-in strain relief
- Glass passivated chip junction or Planar chip (< 10 V)
- Typical $I_R < 1 \mu A$ when V_{BR} min > 12 V
- High temperature reflow soldering guaranteed: 260 °C / 40 sec
- $V_{BR} @ T_J = V_{BR}@25 \text{ °C} \times (1 + \alpha T \times (T_J - 25))$
(αT : Temperature Coefficient, typical value is 0.1%)
- UL Recognized compound meeting flammability rating V-0
- Meet MSL level1, per J-STD-020
- Matte tin lead-free plated
- Halogen free and RoHS compliant
- Pb-free E3 means 2ND level interconnect is Pb-free and the terminal finish material is tin(Sn) (IPC/JEDEC J-STD-609A.01)

TVS Diodes

Transient Voltage Suppression Diodes

SMA6L Series

Package Outline Dimensions (DO-221AC)

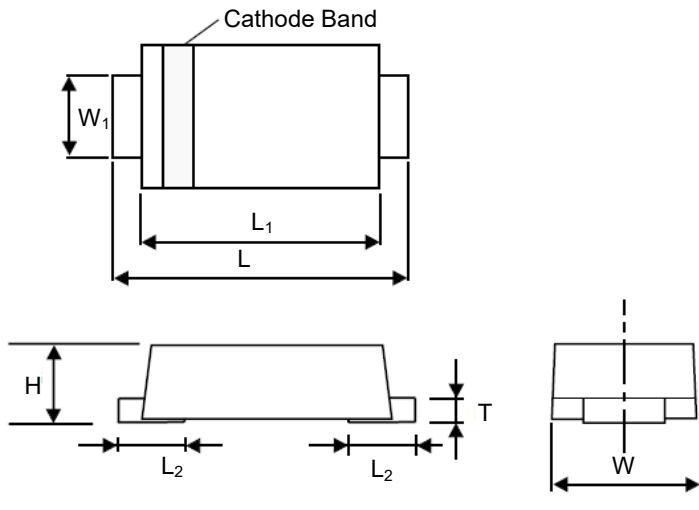

Symbol	Millimeters		Inches	
	Min.	Max.	Min.	Max.
L_1	3.95	4.60	0.156	0.181
L	4.80	5.60	0.189	0.220
W_1	1.25	1.75	0.049	0.069
W	2.25	2.95	0.088	0.116
L_2	0.75	1.50	0.030	0.059
T	0.125	0.250	0.005	0.010
H	0.90	1.10	0.035	0.043

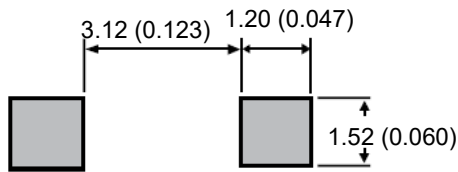

Mounting Pad Layout

Maximum Ratings and Characteristics

($T_A = 25\text{ }^\circ\text{C}$ unless otherwise specified.)

Parameter	Symbol	Value	Unit
Peak Pulse Power Dissipation at $T_A=25\text{ }^\circ\text{C}$ by 10/1000 μs Waveform (Fig.2) (Note 1,2,3)	P_{PPM}	600	W
Power Dissipation on Infinite Heat Sink at $T_L=50\text{ }^\circ\text{C}$	P_D	3	W
Peak Forward Surge Current, 8.3 ms Single Half Sine Wave (Note 4)	I_{FSM}	60	A
Maximum Instantaneous Forward Voltage at 25 A for Unidirectional Only	V_F	3.5	V
Operating Temperature Range	T_J	-65 to 150	$^\circ\text{C}$
Storage Temperature Range	T_{STG}	-65 to 175	$^\circ\text{C}$
Typical Thermal Resistance Junction to Lead	$R_{\theta JL}$	35	$^\circ\text{C} / \text{W}$
Typical Thermal Resistance Junction to Ambient	$R_{\theta JA}$	200	$^\circ\text{C} / \text{W}$

Notes

1. Non-repetitive current pulse, per Fig. 4 and derated above $T_J(\text{initial})=25\text{ }^\circ\text{C}$ per Fig. 3.
2. Mounted on 5.0 x 5.0 mm copper pad to each terminal.
3. SMA6L150A~SMA6L250A Peak Pulse Power Dissipation by 10/1000 μs Waveform (PPPM) is 400 W.
4. Measured on 8.3 ms single half sine wave or equivalent square wave for unidirectional device only.

TVS Diodes

Transient Voltage Suppression Diodes

SMA6L Series

Part Numbering System

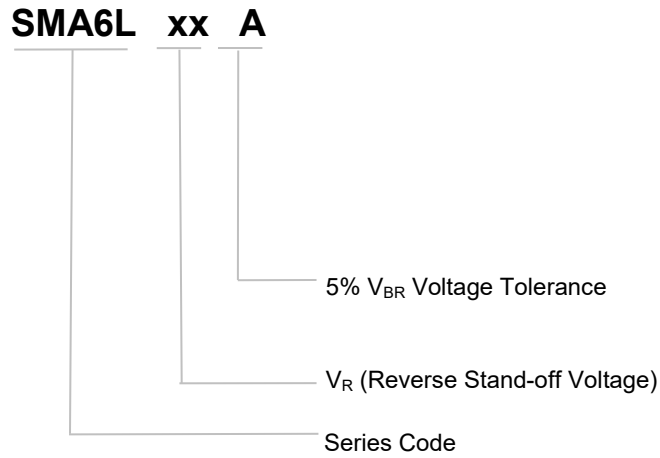

Marking

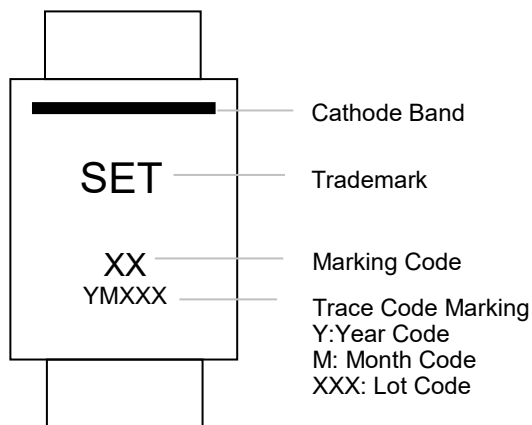

TVS Diodes

Transient Voltage Suppression Diodes

SMA6L Series

Electrical Characteristics (T_A=25 °C unless otherwise noted)

Part Number	Device Marking Code	Breakdown Voltage V _{BR} @I _T		Test Current I _T	Reverse Stand-off Voltage V _R	Max. Reverse Leakage I _R @V _R	Max. Peak Pulse Current I _{PPM}	Max. Clamping Voltage V _C @I _{PPM}
		Min	Max					
Uni	Uni	(V)		(mA)	(V)	(μA)	(A)	(V)
SMA6L5.0A	AE	6.40	7.00	10	5.00	800.00	65.30	9.20
SMA6L6.0A	AG	6.67	7.37	10	6.00	800.00	58.30	10.30
SMA6L6.5A	AK	7.22	7.98	10	6.50	500.00	53.60	11.20
SMA6L7.0A	AM	7.78	8.60	10	7.00	200.00	50.00	12.00
SMA6L7.5A	AP	8.33	9.21	1	7.50	100.00	46.60	12.90
SMA6L8.0A	AR	8.89	9.83	1	8.00	50.00	44.20	13.60
SMA6L8.5A	AT	9.44	10.40	1	8.50	20.00	41.70	14.40
SMA6L9.0A	AV	10.00	11.10	1	9.00	10.00	39.00	15.40
SMA6L10A	AX	11.10	12.30	1	10.00	5.00	35.30	17.00
SMA6L11A	AZ	12.20	13.50	1	11.00	1.00	33.00	18.20
SMA6L12A	BE	13.30	14.70	1	12.00	1.00	30.20	19.90
SMA6L13A	BG	14.40	15.90	1	13.00	1.00	28.00	21.50
SMA6L14A	BK	15.60	17.20	1	14.00	1.00	25.90	23.20
SMA6L15A	BM	16.70	18.50	1	15.00	1.00	24.60	24.40
SMA6L16A	BP	17.80	19.70	1	16.00	1.00	23.10	26.00
SMA6L17A	BR	18.90	20.90	1	17.00	1.00	21.80	27.60
SMA6L18A	BT	20.00	22.10	1	18.00	1.00	20.60	29.20
SMA6L20A	BV	22.20	24.50	1	20.00	1.00	18.60	32.40
SMA6L22A	BX	24.40	26.90	1	22.00	1.00	16.90	35.50
SMA6L24A	BZ	26.70	29.50	1	24.00	1.00	15.50	38.90
SMA6L26A	CE	28.90	31.90	1	26.00	1.00	14.30	42.10
SMA6L28A	CG	31.10	34.40	1	28.00	1.00	13.30	45.40
SMA6L30A	CK	33.30	36.80	1	30.00	1.00	12.40	48.40
SMA6L33A	CM	36.70	40.60	1	33.00	1.00	11.30	53.30
SMA6L36A	CP	40.00	44.20	1	36.00	1.00	10.40	58.10

TVS Diodes

Transient Voltage Suppression Diodes

SMA6L Series

Part Number	Device Marking Code	Breakdown Voltage $V_{BR}@I_T$		Test Current I_T	Reverse Stand-off Voltage V_R	Max. Reverse Leakage $I_R@V_R$	Max. Peak Pulse Current I_{PPM}	Max. Clamping Voltage $V_C@I_{PPM}$
		Min	Max					
Uni	Uni	(V)		(mA)	(V)	(μ A)	(A)	(V)
SMA6L40A	CR	44.40	49.10	1	40.00	1.00	9.30	64.50
SMA6L43A	CT	47.80	52.80	1	43.00	1.00	8.70	69.40
SMA6L45A	CV	50.00	55.30	1	45.00	1.00	8.30	72.70
SMA6L48A	CX	53.30	58.90	1	48.00	1.00	7.80	77.40
SMA6L51A	CZ	56.70	62.70	1	51.00	1.00	7.30	82.40
SMA6L54A	RE	60.00	66.30	1	54.00	1.00	6.90	87.10
SMA6L58A	RG	64.40	71.20	1	58.00	1.00	6.50	93.60
SMA6L60A	RK	66.70	73.70	1	60.00	1.00	6.20	96.80
SMA6L64A	RM	71.10	78.60	1	64.00	1.00	5.90	103.00
SMA6L70A	RP	77.80	86.00	1	70.00	1.00	5.30	113.00
SMA6L75A	RR	83.30	92.10	1	75.00	1.00	5.00	121.00
SMA6L78A	RT	86.70	95.80	1	78.00	1.00	4.80	126.00
SMA6L85A	RV	94.40	104.00	1	85.00	1.00	4.40	137.00
SMA6L90A	RX	100.00	111.00	1	90.00	1.00	4.20	146.00
SMA6L100A	RZ	111.00	123.00	1	100.00	1.00	3.70	162.00
SMA6L 110A	SE	122.00	135.00	1	110.00	1.00	3.40	177.00
SMA6L120A	SG	133.00	147.00	1	120.00	1.00	3.20	193.00
SMA6L 130A	SK	144.00	159.00	1	130.00	1.00	2.90	209.00
SMA6L150A	SM	167.00	185.00	1	150.00	1.00	1.65	243.00
SMA6L160A	SP	178.00	197.00	1	160.00	1.00	1.55	259.00
SMA6L170A	SR	189.00	209.00	1	170.00	1.00	1.50	275.00
SMA6L180A	ST	201.00	222.00	1	180.00	1.00	1.40	292.00
SMA6L185A	SU	209.00	231.00	1	185.00	1.00	1.40	303.00
SMA6L200A	SV	224.00	247.00	1	200.00	1.00	1.25	324.00
SMA6L215A	SW	237.00	263.00	1	215.00	1.00	1.17	344.00
SMA6L220A	SX	246.00	272.00	1	220.00	1.00	1.13	356.00
SMA6L250A	SZ	279.00	309.00	1	250.00	1.00	0.95	405.00

TVS Diodes

Transient Voltage Suppression Diodes

SMA6L Series

I-V Curve Characteristics

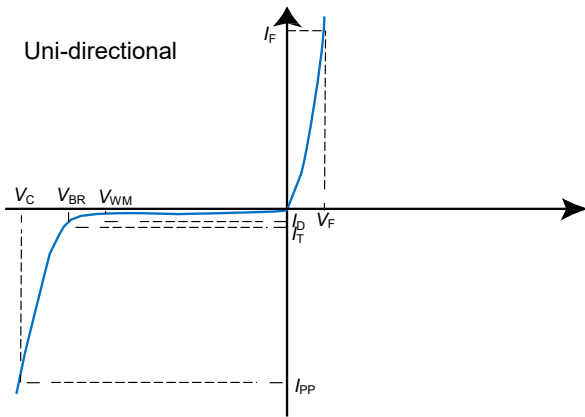

Performance Curve for Reference ($T_A=25^\circ\text{C}$ unless otherwise noted)

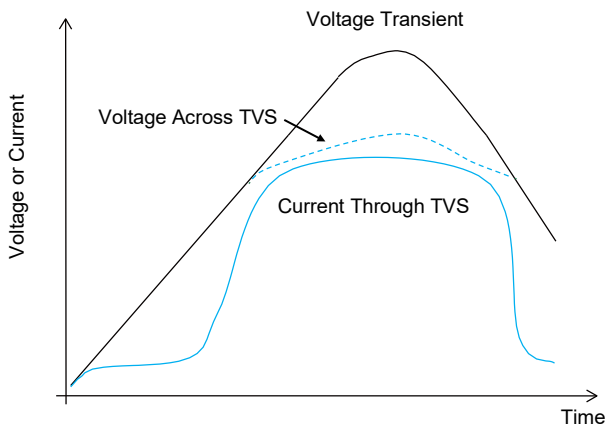

FIGURE 1 TVS Transients Clamping Waveform

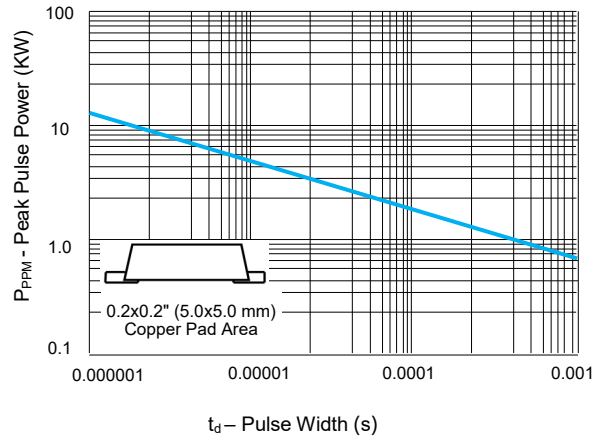

FIGURE 2 Peak Pulse Power Rating Curve

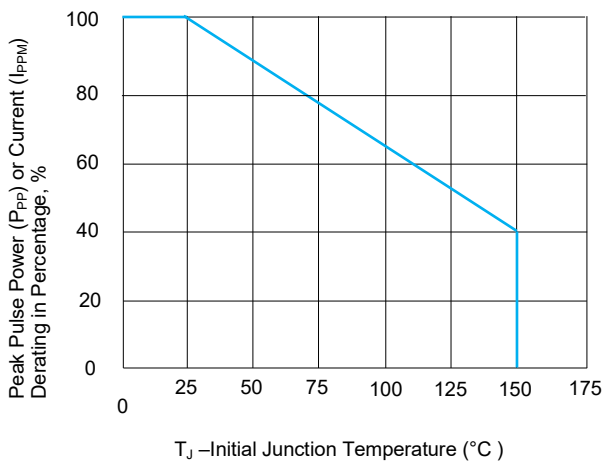

FIGURE 3 Peak Pulse Power Derating Curve

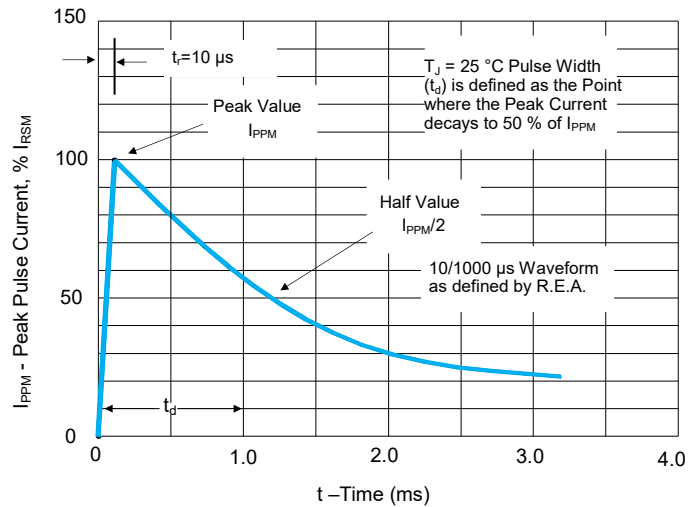

FIGURE 4 Pulse Waveform

TVS Diodes

Transient Voltage Suppression Diodes

SMA6L Series

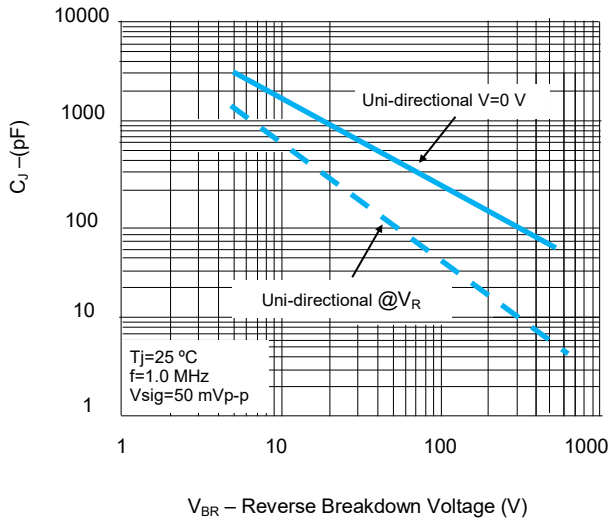

FIGURE 5 Typical Junction Capacitance

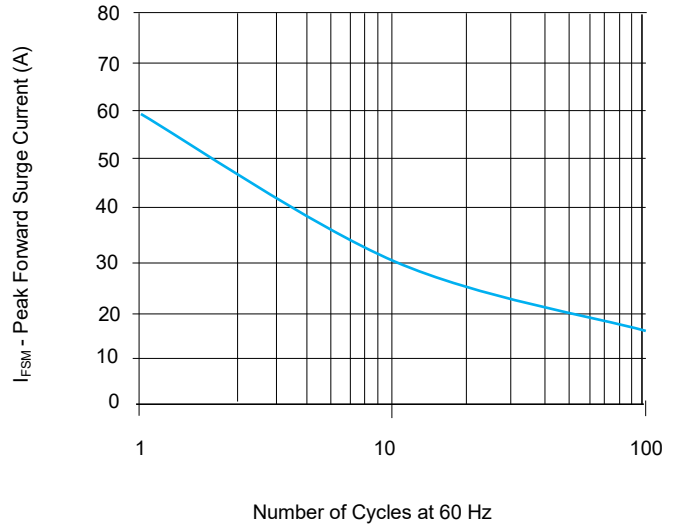

FIGURE 6 Maximum Non-Repetitive Forward Surge Current Uni-Directional only

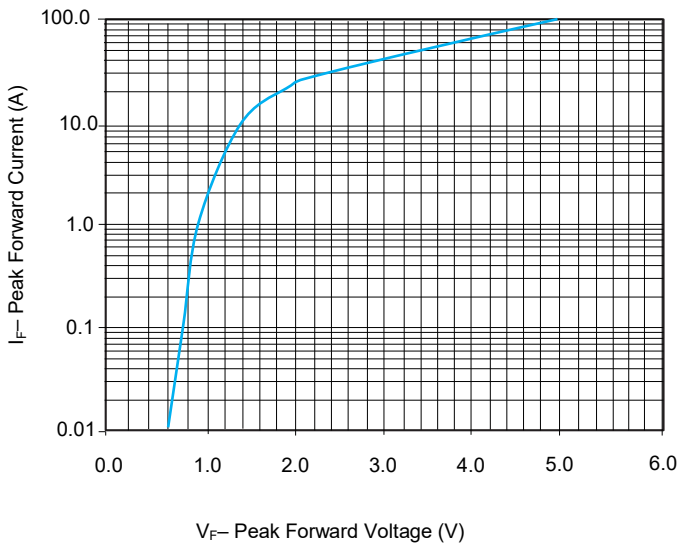

FIGURE 7 Peak Forward Drop vs Peak Forward Current (Typical Values)

Environmental Specifications

High Temp. Storage	JESD22-A103
HTRB	JESD22-A108
Temperature Cycling	JESD22-A104
MSL	JEDEC-J-STD-020, Level 1
H3TRB	JESD22-A101
RSH	JESD22-A111

Physical Specifications

Weight	0.002 ounce, 0.032 gram
Case	JEDEC DO-221AC Molded Plastic over glass passivated junction
Polarity	Color band denotes cathode except Bipolar
Terminal	Matte Tin-plated leads, Solderable per JESD22-B102

Soldering Parameters

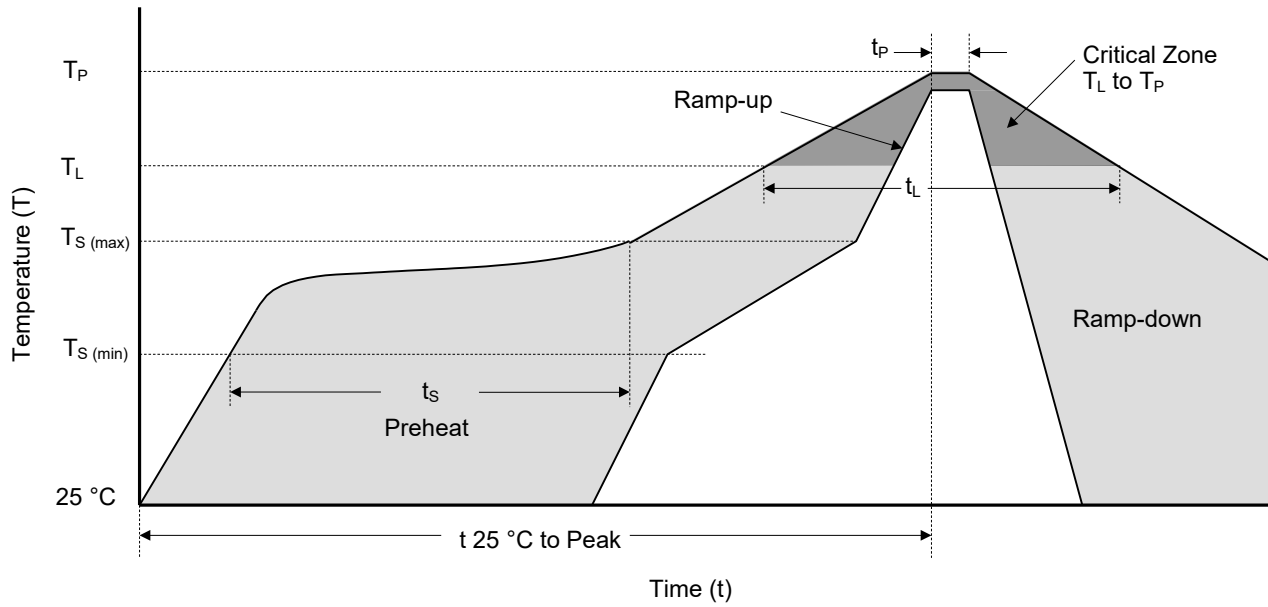

Reflowing Condition

Reflow Condition		Lead-Free Assembly
Pre-heat	Temperature Min ($T_{S (min)}$)	150 °C
	Temperature Max ($T_{S (max)}$)	200 °C
	Time (min to max) (T_S)	60 ~ 120 seconds
Average ramp up rate (Liquidus Temp (T_L) to peak)		3 °C / second max.
$T_S (max)$ to T_L -Ramp-up Rate		3 °C / second max.
Reflow	Temperature (t_L) (Liquidus)	217 °C
	Time (Min to Max) (t_L)	60 ~ 150 seconds
Peak Temperature (T_P)		260 ^{+0/-5} °C
Time Within 5 °C of Actual Peak Temperature (t_p)		20 ~ 40 seconds
Ramp-down Rate		6 °C / second max.
Time 25 °C to Peak Temperature		8 Minutes max.
Do Not Exceed		260 °C

TVS Diodes

Transient Voltage Suppression Diodes

SMA6L Series

Packaging Information

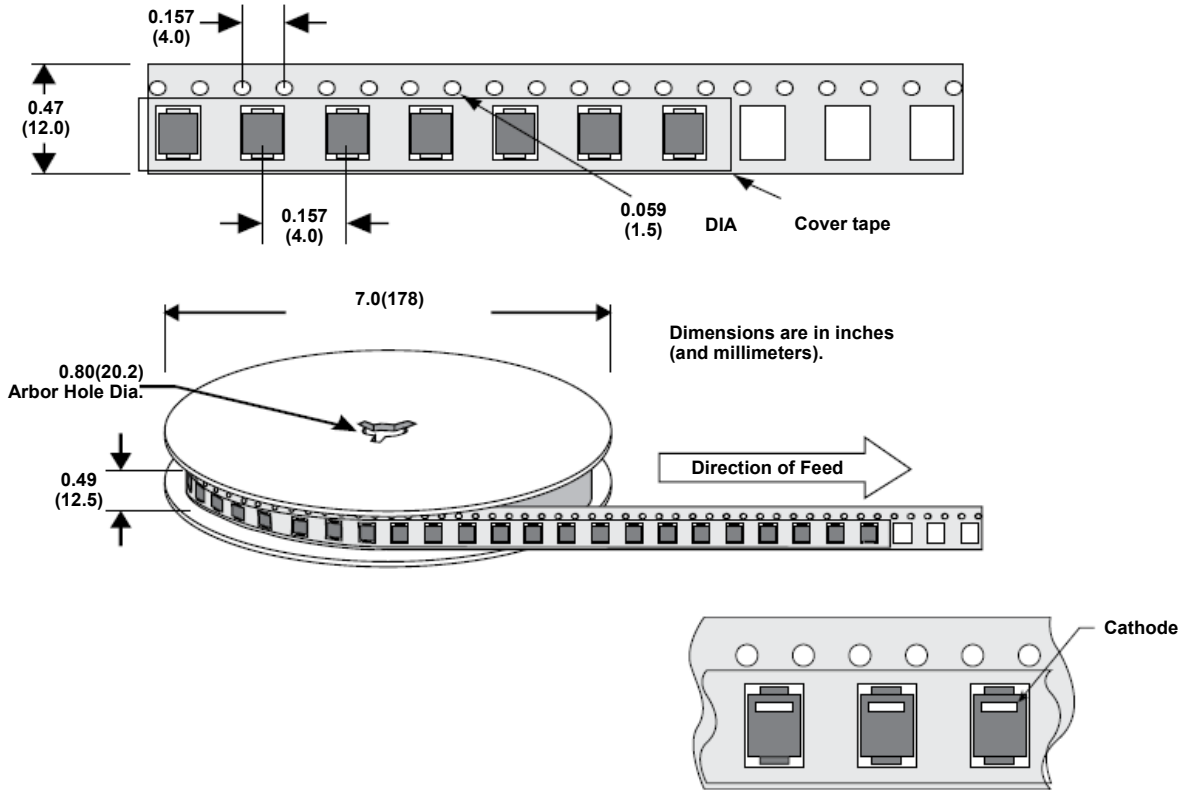

Part Number	Package	QTY (Reel)	Packaging Option	Packaging Specification
SMA6LxxA	DO-221AC	2000 PCS	Tape & Reel – 12 mm/7" tape	EIA RS-481

Glossary

Item	Description
V_C	Clamping Voltage Voltage across TVS in a region of low differential resistance that serves to limit the voltage across the device terminals.
V_R	Reverse Stand-off Voltage Maximum voltage that can be applied to the TVS without operation. NOTE : It is also shown as V_{WM} (maximum working voltage (maximum d.c. voltage)) and known as rated stand-off voltage (V_{SO}).
I_R	Reverse Leakage Current Current measured at V_R . NOTE : Also shown as I_D for stand-by current.
V_{BR}	Breakdown Voltage Voltage across TVS at a specified current I_T in the breakdown region.
I_{PPM}	Rated Random Recurring Peak Impulse Current Maximum-rated value of random recurring peak impulse current that may be applied to a device.
$P_{M(AV)}$	Rated Average Power Dissipation Maximum-rated value of power dissipation resulting from all sources, including transients and standby current, averaged over a short period of time.
P_{PPM}	Rated Random Recurring Peak Impulse Power Dissipation Maximum-rated value of the product of rated random recurring peak impulse current (I_{PPM}) multiplies by specified maximum clamping voltage (V_C).
C_J	Capacitance Capacitance across the TVS measured at a specified frequency and voltage.
V_{FS}	Peak Forward Surge Voltage Peak voltage across an TVS for a specified forward surge current (I_{FS}) and time duration. NOTE : Also shown as V_F .
I_{FS}	Forward Surge Current Pulsed current through TVS in the forward conducting region. NOTE : Also shown as I_F .
$\alpha_{V(BR)}$	Temperature Coefficient of Breakdown Voltage The change of breakdown voltage divided by the change of temperature.
I_{PP}	Peak pulse Current Peak pulse current value applied across the TVS to determine the clamping voltage V_C for a specified wave shape.
I_T	Pulsed D.C. Test Current Test current for measurement of the breakdown voltage V_{BR} . This is defined by the manufacturer and usually given in milliamperes with a pulse duration of less than 40 ms. NOTE : Also shown as I_{BR} .

—(GB-T 18802.321 / IEC 61643-321 / JESD210A)



ATTENTION

Usage

1. TVS must be operated in the specified ambient temp.
2. Do not clean the TVS with strong polar solvent such as ketone, esters, benzene and halogenated hydrocarbon, to avoid damaging the encapsulating layer.
3. Please do not apply severe vibration, shock or pressure to TVS, to avoid element cracking.

Replacement

1. If TVS is visually damaged, please replace it.
2. TVS is a non-repairable product. For safety sake, please use equivalent TVS for replacement.

Storage

1. Storage Temp. Range: (-55 to 150) °C.
2. Do not store the TVS at the high temp., high humidity or corrosive gas environment, to avoid influencing the solder- ability of the lead wires. The product shall be used up within 1 year after receiving the goods.

Environmental Conditions

1. TVS should not be exposed to the open air, nor direct sunshine.
2. TVS should avoid rain, water vapor or other condition of high temp. and high humidity.
3. TVS should avoid sand dust, salt mist, or other harmful gases.

Max. Typical Capacitance of TVS

The typical capacitance of TVS is listed in the specifications. Designers may refer to it when designing TVS in High frequency circuit.

Installation Mechanical Stress

1. Do not knock TVS when installing, to avoid mechanical damage.
2. Please do not apply severe vibration, shock or pressure to TVS, to avoid surface resin or element cracking.

Transient Voltage Suppressor (Surface Mount) Features Overview

Package Type	Series	Series	Series	Series	Series	Series	Series	Series	Series
DO-221AC						SMA6L			
DO-214AA							SACB	SMBJ	P6SMB
DO-214AB									
DO-214AC			SMAJ	P4SMA	SMA6J				
SOD-123FL	SMF	P4SMF							
SMT0-218									
Product Outline (mm)									
V_R / V_{WM} (V) Reverse Stand-off Voltage	5.0 ~ 250	5.0 ~ 85	5.0 ~ 440	5.8 ~ 468	5.0 ~ 250	5.0 ~ 50	5.0 ~ 440	5.8 ~ 512	
P_{PPM} (W) (10/1000 μ s) Rated Peak ImPulse Power Dissipation	200		400		600	500	600		
I_{PPM} (kA)(8/20 μ s) Rated Peak ImPulse Current									
Operating Temperature (°C)	-55 to +150								

Transient Voltage Suppressor (Surface Mount) Features Overview

Package Type	Series									
	DO-221AC	DO-214AA	DO-214AB	DO-214AC	SOD-123FL	SMT0-218	SPC1	SPC3	SPC6	SPC10
	<input type="checkbox"/>	<input type="checkbox"/>	<input type="checkbox"/>	<input type="checkbox"/>	<input type="checkbox"/>	<input type="checkbox"/>	<input type="checkbox"/>	<input type="checkbox"/>	<input type="checkbox"/>	<input type="checkbox"/>
	<input type="checkbox"/>	<input type="checkbox"/>	<input type="checkbox"/>	<input type="checkbox"/>	<input type="checkbox"/>	<input type="checkbox"/>	<input type="checkbox"/>	<input type="checkbox"/>	<input type="checkbox"/>	<input type="checkbox"/>
	SMCJ	1.5SMC	3.0SMCJ	SMDJ	5.0SMDJ					
	<input type="checkbox"/>	<input type="checkbox"/>	<input type="checkbox"/>	<input type="checkbox"/>	<input type="checkbox"/>	<input type="checkbox"/>	<input type="checkbox"/>	<input type="checkbox"/>	<input type="checkbox"/>	<input type="checkbox"/>
	<input type="checkbox"/>	<input type="checkbox"/>	<input type="checkbox"/>	<input type="checkbox"/>	<input type="checkbox"/>	<input type="checkbox"/>	<input type="checkbox"/>	<input type="checkbox"/>	<input type="checkbox"/>	<input type="checkbox"/>
	<input type="checkbox"/>	<input type="checkbox"/>	<input type="checkbox"/>	<input type="checkbox"/>	<input type="checkbox"/>	<input type="checkbox"/>	SPC1	SPC3	SPC6	SPC10
Product Outline (mm)										
V_R / V_{WM} (V) Reverse Stand-off Voltage	5.0 ~ 440	5.8 ~ 512	5.0 ~ 440	12 ~ 170	380 / 430	66	58 ~ 76	58 ~ 86		
P_{PPM} (W) (10/1000 μ s) Rated Peak ImPulse Power Dissipation	1500	3000	5000							
I_{PPM} (kA)(8/20 μs) Rated Peak ImPulse Current						1	3	6	10	
Operating Temperature (°C)		-55 to +150					-55 to +125			

Transient Voltage Suppressor (Axial Lead) Features Overview

Package Type	Series																	
	DO-201	DO-41	DO-15	P600	Radial lead	1.5KE	LCE	5KP	15KPA	20KPA	30KPA	SPCL1	SPCL3	SPCL6	SPCL10	SPCL15	SPCL20	
Product Outline (mm)																		
V_R / V_{WM} (V) Reverse Stand-off Voltage	5.8 ~ 468	5.0 ~ 50	5.8 ~ 512	5.8 ~ 512	6.5 ~ 90	5.0 ~ 250	17 ~ 280	20 ~ 300	28 ~ 360	76	15 ~ 430	30 ~ 430	15 ~ 530	58 ~ 380	16 ~ 76			
P_{PPM} (W) (10/1000 μ s) Rated Peak ImPulse Power Dissipation	400	500	600	1500	5000	15000	20000	30000										
I_{PPM} (kA)(8/20 μ s) Rated Peak ImPulse Current										1	3	6	10	15	20			
Operating Temperature (°C)									-55 to +150									-55 to +125